

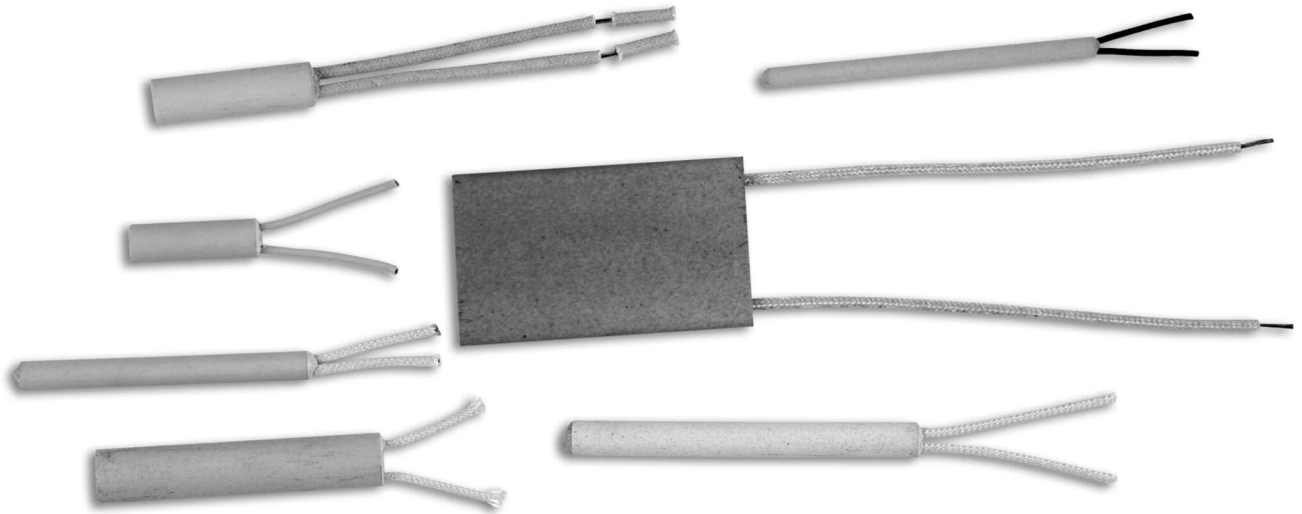

Ceramic Heaters



CERAMIC

U.L. Recognized-No. E56973
C.S.A. Certified-No. 016386-0-000

Applications

Copiers, Dehumidifiers, Glue Guns, Heat Sealing Tools, Instrumentation, Resistors, Soldering and Desoldering Equipment, Valve Heaters.

Features

- The Hotwatt Ceramic Heater is a ceramic body encasing a resistance element and packed within magnesium oxide.
- The heaters are terminated with flexible insulated lead wires.
- Temperatures to 1300°F (705°C).

Construction

- 1 Ceramic body.
- 2 Premium grade resistance wire element.
- 3 Magnesium oxide packaging.
- 4 Ceramic end seal.
- 5 Flexible insulated lead wires.

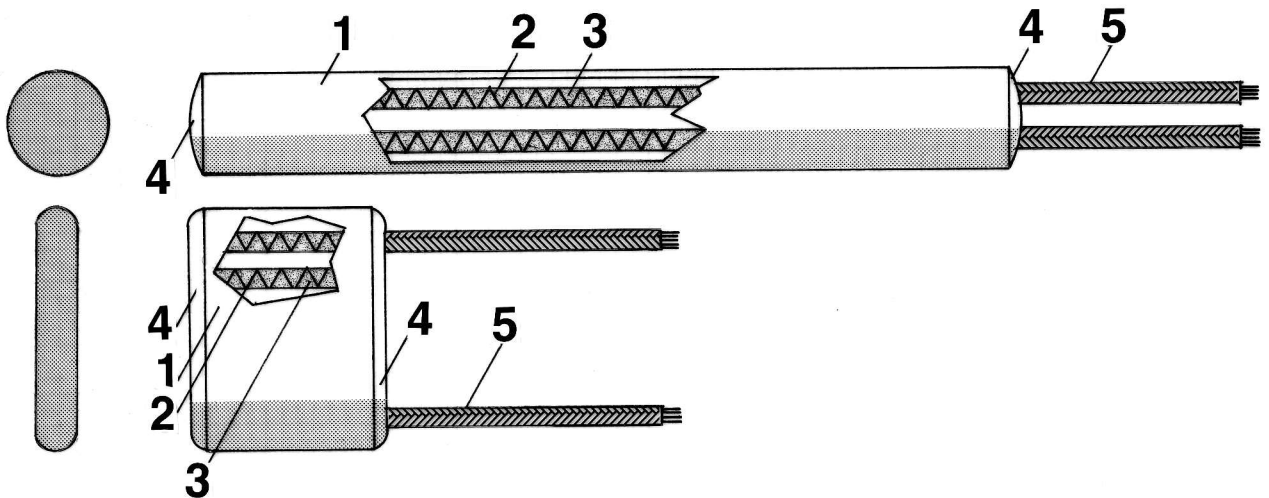



Ceramic Heaters

Round Ceramic Sizes

Length	Catalog Number	Maximum Wattage	Diameter
1 1/2"	CB216 - 1.50	40	.216
1 1/2"	CB255 - 1.50	50	.255
1"	CB307 - 1.00	40	.307
1 1/2"	CB307 - 1.50	60	.307
1 3/4"	CB307 - 1.75	70	.307
1 5/16"	CB374 - 1.56	75	.374
1 3/4"	CB374 - 1.75	85	.374
1 3/8"	CB435 - 1.37	85	.435
1 5/16"	CB435 - 1.56	90	.435
2 1/4"	CB435 - 2.25	125	.435
2 1/4"	CB580 - 2.25	160	.580
1"	CB625 - 1.00	80	.625
2"	CB625 - 2.00	160	.625
1 7/16"	CB690 - 1.43	120	.690
2"	CB875 - 2.00	220	.875
2"	CB940 - 2.00	240	.940

Rectangular Ceramic Sizes

Length	Catalog Number	Maximum Wattage	Thickness	Width
2"	CB18 - .93 -2.00	150	.180	.930
2"	CB18 - .56 -2.00	90	.187	.560
2"	CB19 - .60 -2.00	80	.190	.605
2 1/2"	CB19 - .60 -2.50	120	.190	.605
1 1/16"	CB25 - 1.37-1.06	150	.250	1 3/8"
1 3/4"	CB25 - 1.37-1.75	190	.250	1 3/8"
2 3/8"	CB25 - 1.37-2.37	260	.250	1 3/8"
2"	CB25 - 1.62 -2.00	250	.250	1 5/8"

The above listings are a sampling of sizes that are available. Other sizes and lengths as well as custom sizes are available. Consult factory for details and availability.

Standard Termination

SF1: Flexible leads for applications where leads can be bent close to the end of the unit. Leads are non-repairable.

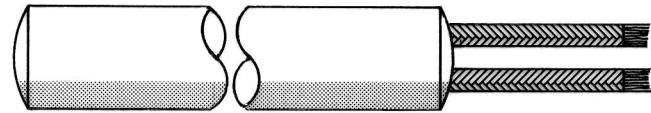

Special Features

SF11A: Ring terminals. Specify #6, #8, or #10.



SF11B: Straight quick connect terminals. Specify male or female and size: 3/16" or 1/4".



SF11C: Flag quick connect terminals. Specify male or female and size: 3/16" or 1/4".



SF11D: Space terminals. Specify #6, #8, or #10.



Wattage

Normal wattage is based on 40 Watts per square inch of heated length. When installed in a proper heat sink. Lower or higher wattages are available depending on the application.

Voltage

Voltage is normally 120 or 240 volts. Lower voltages are available.

How to Order

Specify: Catalog number, wattage, voltage and lead length.

Example: CB255-1.50/50W120V/SF1-3.